



## fan data

05.11.2024

version FANselect V 1.01 (241105), AMCA V 1.03 September, 2021&lt;br&gt;RLT V 1.00 Dezember, 2021 / 1.24.11.05 | 30813 | (user ZAFS20813)



type	<b>FN080-SDI.6N.V7</b>
article no.	153512   Portfolio STD-WW

## technical data

motor		AC
mains supply	-	3~ 400V 50Hz D
nominal current ( $I_N$ )	A	3.90
ambient temperature, max. limit ( $t_r$ )	°C	65
efficiency grade $\eta_{statA}$	%	36,8
efficiency grade $N_{actual}$   $N_{target}$		<b>41,5</b>   40
ErP-conformity		2015
grille   influence		pressure side   not measured

## fan data

frequency ( $f_{DP}$ )   ( $f_{max}$ )	Hz	<b>50</b>   50
dimensions (w x h x d)	mm	861 x 861 x 273
product weight ( $m_{pr}$ )	kg	36.1

PF:PF\_50; Type:FN080; STol:+-10 %

# FANselect



## performance curve / acoustics

05.11.2024

Version FANselect V 1.01 (241105), AMCA V 1.03 September, 2021 <br> RLT V 1.00 Dezember, 2021 / 1.24.11.05 | 30813 | (user ZAFS20813)

### 1 FN080-SDI.6N.V7

Measured in full nozzle without guard grille in air flow direction V in installation type A according to ISO5801

153512 | Portfolio STD-WW measurement density 1.19 [kg/m³]

### air performance $p_{sF}$

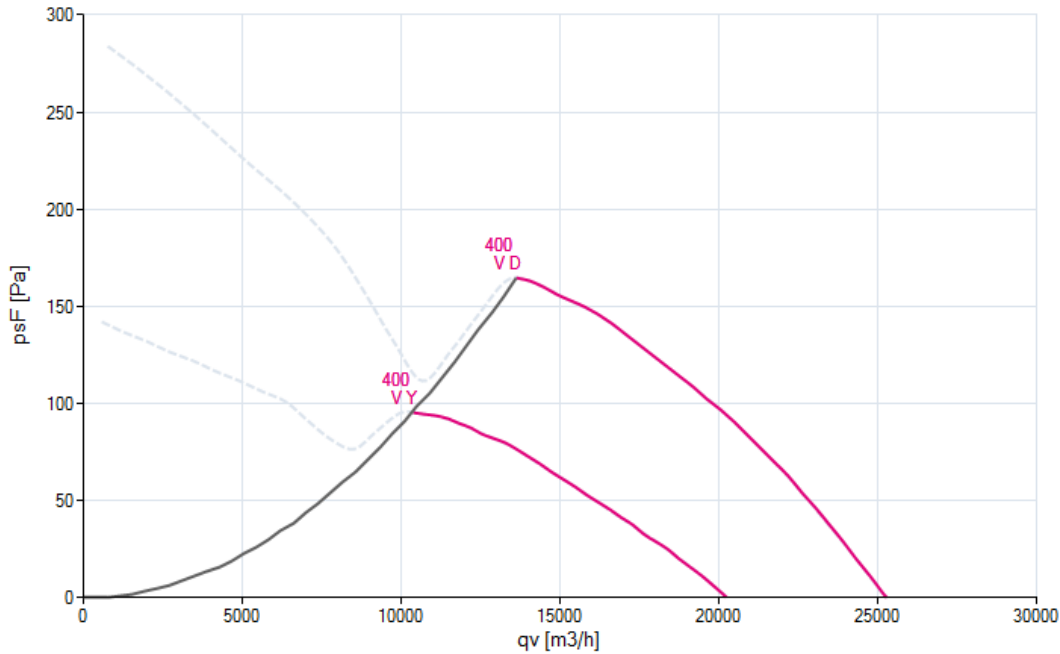

### acoustics ( $L_{w(A),5}$ )

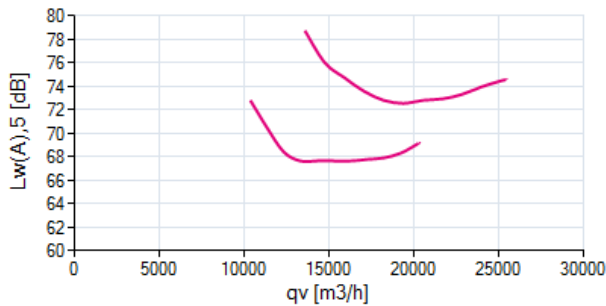

### acoustics ( $L_{w(A),6}$ )

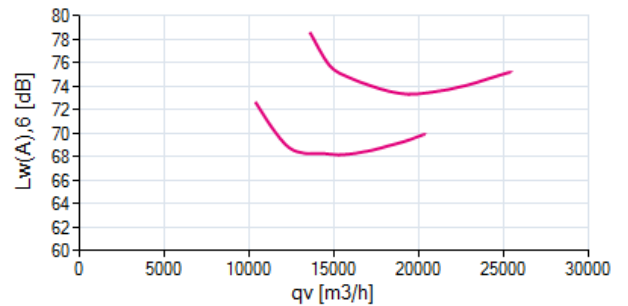

### 1 FN080-SDI.6N.V7

f [Hz]	sum	63	125	250	500	1000	2000	4000	8000
$L_{w(A),5}$	-	-	-	-	-	-	-	-	-
$L_{w,5}$	-	-	-	-	-	-	-	-	-

f [Hz]	sum	63	125	250	500	1000	2000	4000	8000
$L_{w(A),6}$	-	-	-	-	-	-	-	-	-
$L_{w,6}$	-	-	-	-	-	-	-	-	-

# FANselect



## efficiency grade / power input

05.11.2024

version FANselect V 1.01 (241105), AMCA V 1.03 September, 2021 <br> RLT V 1.00 Dezember, 2021 / 1.24.11.05 | 30813 | (user ZAFS20813)

1

**FN080-SDI.6N.V7**

Measured in full nozzle without guard grille in air flow direction V in installation type A according to ISO5801

153512 | Portfolio STD-WW

measurement density 1.19 [kg/m³]

efficiency grade  $\eta_F$

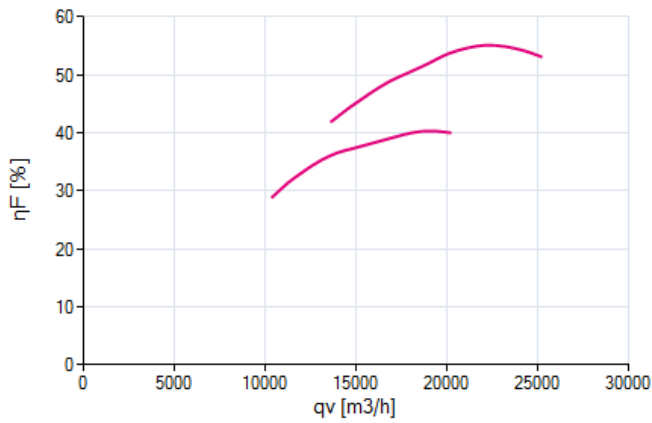

efficiency grade  $\eta_{sF}$

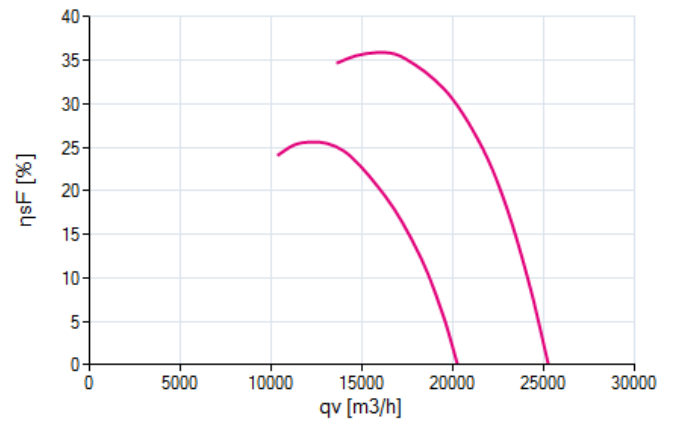

power input  $P_1$

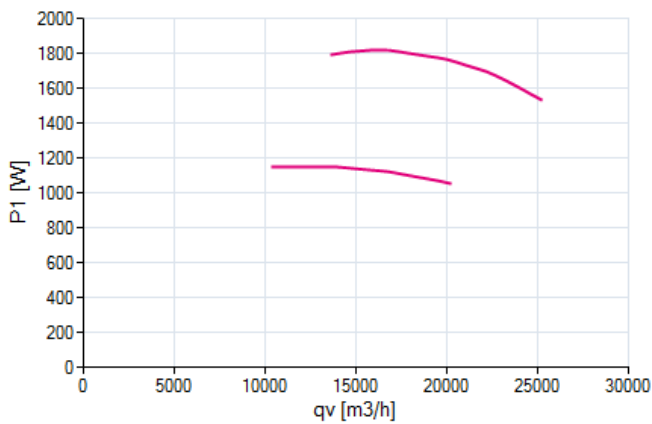



## nominal values

05.11.2024

version FANselect V 1.01 (241105), AMCA V 1.03 September, 2021<br>RLT V 1.00 Dezember, 2021 / 1.24.11.05 | 30813 | (user ZAFS20813)

1



**FN080-SDI.6N.V7**

153512

3~ 400V Y/D 50Hz P1 1.15/1.80kW P2 0.65/1.35kW  
2.20/3.90A DI=5% 700/900/MIN COSY 0.68 65°C  
IP54 THCL155

## drawing

05.11.2024

version FANselect V 1.01 (241105), AMCA V 1.03 September, 2021<br>RLT V 1.00 Dezember, 2021 / 1.24.11.05 | 30813 | (user ZAFS20813)

1



**FN080-SDI.6N.V7**

153512

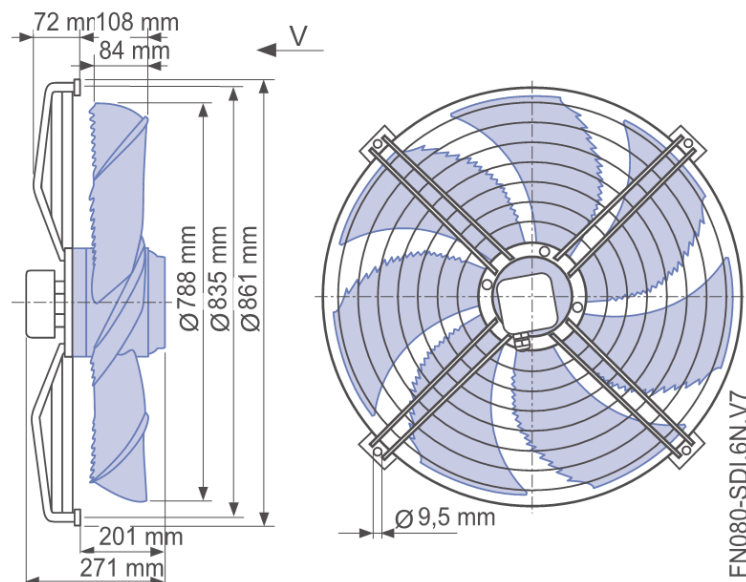

FN080-SDI.6N.V7

## wiring diagram

05.11.2024

version FANselect V 1.01 (241105), AMCA V 1.03 September, 2021<br>RLT V 1.00 Dezember, 2021 / 1.24.11.05 | 30813 | (user ZAFS20813)

1



**FN080-SDI.6N.V7**

153512

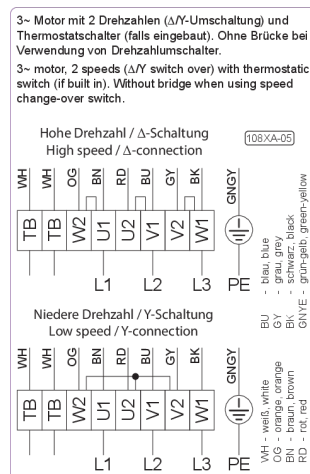



system components

05.11.2024

Version FANselect V 1.01 (241105), AMCA V 1.03 September, 2021<br>RLT V 1.00 Dezember, 2021 / 1.24.11.05 | 30813 | (user ZAFS20813)



type	FN080-SDI.6N.V7
article no.	153512